

Installation Instructions

I - Sheet Number VV07 Rev.A



AUTO VENT SHADE™

Ventvisor® Deflector

For proper installation and best possible fit, please read all instructions **BEFORE** you begin.
For technical assistance or to obtain missing parts, please call Customer Relations at 1-800-241-7219.

Important Safety Information



- CAUTION - Before driving, ensure that the vent visor is properly secured to vehicle.
- Do not use automatic "brush-style" car washes.
- Do not use cleaning solvents of any kind.
- Periodically check all components for tightness.

Contents - 2 Piece Set **NOTE:** Actual product may vary from illustration.

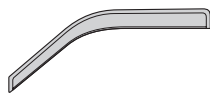

Front Driver Side Visor

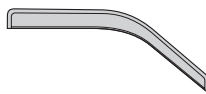

Front Passenger Side Visor

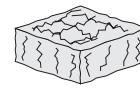

Scotch Brite Pad



Alcohol Pad x2

Contents - 4 Piece Set

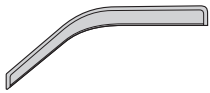

Front Driver Side Visor



Front Passenger Side Visor



Rear Driver Side Visor



Rear Passenger Side Visor

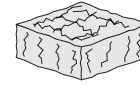

Scotch Brite Pad



Alcohol Pad x4

Tools Required



Car Wash Supplies



Clean Towel

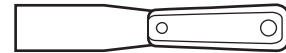

Putty Knife

Preparation Before Painting / Installation

- A trial fit is recommended to ensure proper positioning and fit.
- Check fit of parts before painting as we will not accept the return of modified or painted parts.
- Wash and dry your vehicle to remove any debris and/or dirt from the installation area.

Installation Steps **NOTE:** Actual application may vary slightly from illustrations.



Lower the window & scuff the outside of the rubber window trim where the visor will attach. Clean the scuffed area with an alcohol pad.

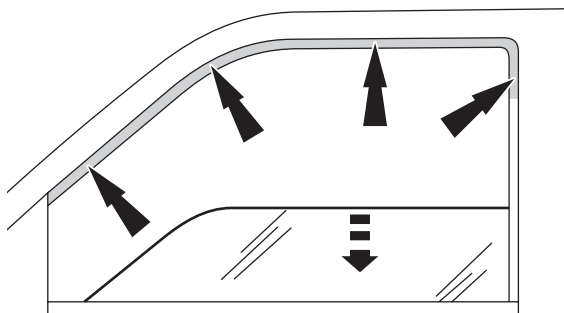

1

Remove the tape liner from the rear flange. Peel back 2" of tape liner from each end of top flange.

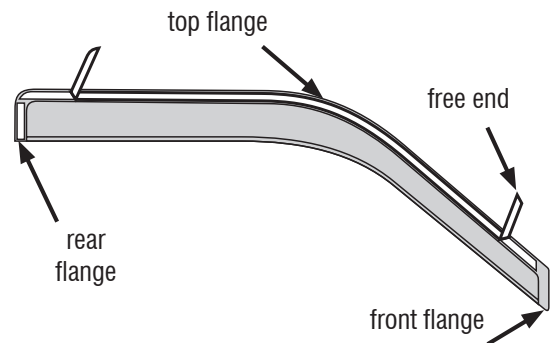

2

Installation Steps

NOTE: Actual application may vary slightly from illustrations.

Slide the front flange behind the mirror cap, use a putty knife to create a gap if needed. Attach the top and rear flanges to the rubber window trim.

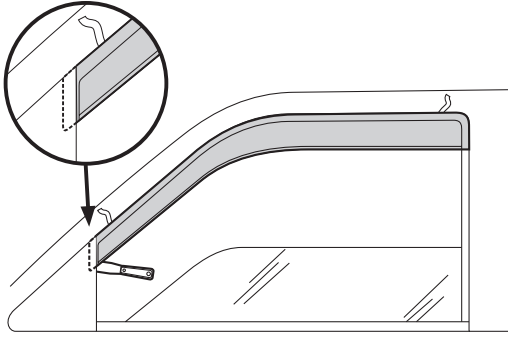

3

Remove tape liner by pulling on free ends. Apply pressure to top and rear tape flanges to secure.

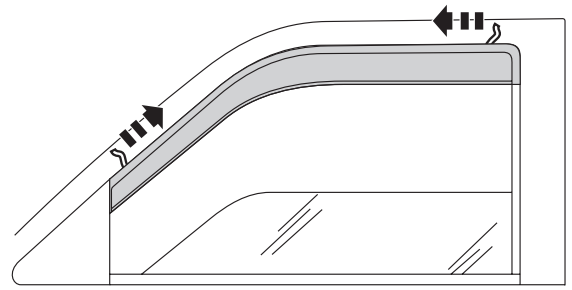

4

4 Piece Set

The rear visor attaches with same preparation methods as the front visor. Attach visor to the vehicle's rubber window trim.

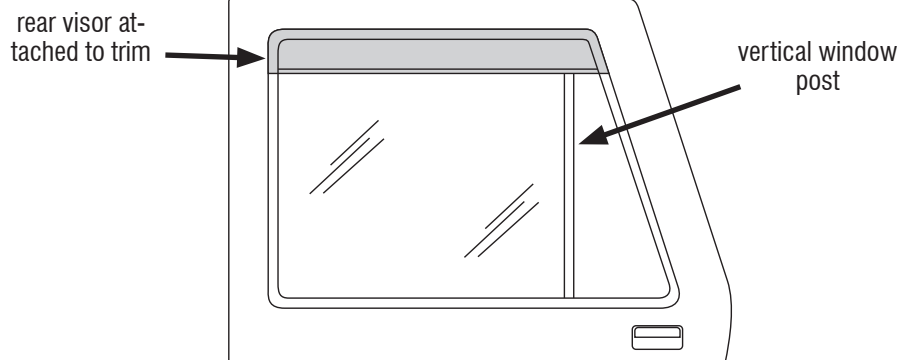

5

Care and Cleaning

- Wash only with mild soap & dry with a clean cloth.

Congratulations!

You have purchased one of the many quality Auto Ventshade™ branded products offered by Lund International, Inc. We take the utmost pride in our products and want you to enjoy years of satisfaction from your investment. We have made every effort to ensure that your product is top quality in terms of fit, durability, finish and ease of installation.



AUTO VENTSHADE™

Lund International, Ventshade Accessories Division

655 Raco Drive, Lawrenceville, GA 30045

800-241-7219 • Fax 770-339-5839 • Visit us at lundinternational.com



© 2005 Lund International, Inc. All rights reserved.

Auto Ventshade™, the Auto Ventshade™ logo and the AVS™ logo are trademarks of Lund International, Inc.





Ventvisor® Deflector

Pour obtenir une installation correcte et le meilleur ajustement possible, lire toutes les instructions AVANT de commencer.
 Pour toute assistance technique ou obtention de pièces manquantes, appeler le service des relations avec la clientèle au 1-800-241-7219.

Informations importantes concernant la sécurité



- ATTENTION – Avant de conduire, s'assurer que la visière est solidement assujettie sur le véhicule.
- Ne pas utiliser les stations de lavage de voitures à brosses.
- Ne pas utiliser de solvants.
- Vérifier régulièrement le serrage des composants.

Contenu - Ensemble 2 pièces

NOTE: Le produit réel peut changer de l'illustration.

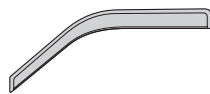

Visière avant côté conducteur

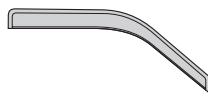

Visière avant côté passager



Scotch Brite garniture



Tampons à l'alcool (2)

Contenu - Ensemble 4 pièces



Visière avant côté conducteur



Visière avant côté passager



Visière arrière côté conducteur



Visière arrière côté passager



Scotch Brite garniture



Tampons à l'alcool (4)

Outils nécessaires



Fournitures pour lavage de voiture



Serviette propre

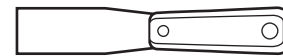

Couteau De Mastic

Préparation pour la peinture/l'installation

- Il est recommandé de procéder à un essai pour s'assurer que le positionnement et l'ajustement sont corrects.
- Vérifier l'ajustement des pièces avant peinture, car nous n'acceptons pas le retour de pièces modifiées ou peintes.
- Laver les glissières de glaces de la portière du véhicule pour éliminer toute poussière et tous débris.
- Sécher les glissières avec une serviette propre.

Étapes d'installation

REMARQUE : La méthode d'application peut être légèrement différente de celle représentée par les illustrations.



Abaisser la glace et frotter l'extérieur de la garniture en caoutchouc de la glace, là où la visière doit être installée. Nettoyer la surface frottée avec un tampon à l'alcool.

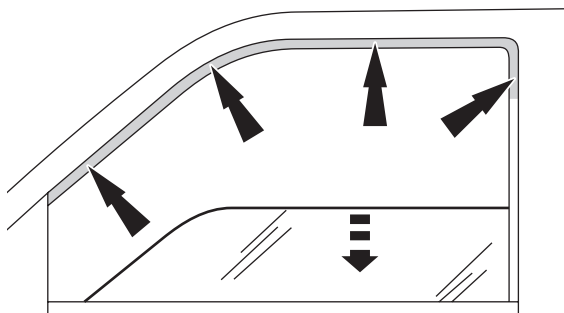

1

Retirer la protection d'adhésif du rebord arrière. Décoller environ 5 cm (2 po) de protection d'adhésif à chaque extrémité du rebord supérieur.

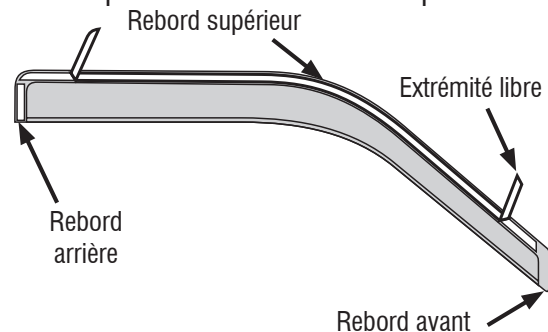

2

Étapes d'installation

REMARQUE : La méthode d'application peut être légèrement différente de celle représentée par les illustrations.

Faire glisser le rebord avant derrière le couvercle du rétroviseur. Au besoin, utiliser un couteau à mastiquer pour permettre le passage du rebord. Fixer le rebord supérieur et le rebord arrière sur la garniture en caoutchouc de la glace.

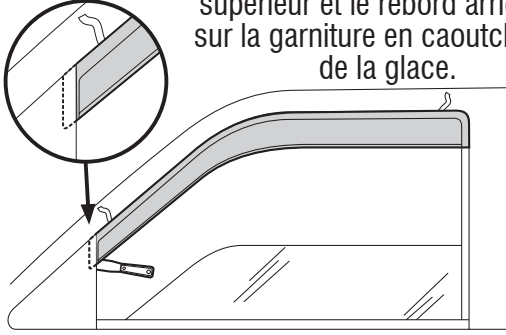

3

Retirer la protection d'adhésif en tirant sur les extrémités libres. Appuyer sur le haut et l'arrière pour faire adhérer le ruban.

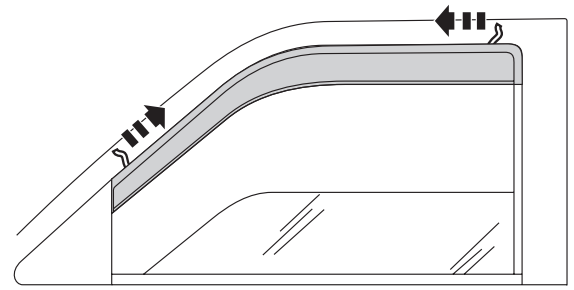

4

Ensemble 4 pièces

L'installation de la visière arrière demande la même préparation que la visière avant. Installer la visière sur la garniture en caoutchouc de la glace du véhicule.

Visière arrière fixée sur la garniture

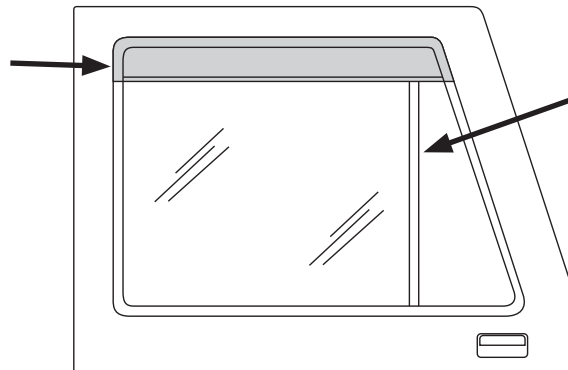

Montant vertical de la glace

5

Entretien et nettoyage

- Laver exclusivement avec de l'eau savonneuse et sécher avec un chiffon propre.

Félicitations !

Vous avez acheté l'un des nombreux produits de qualité Auto Ventshade™ fabriqués par Lund International, Inc. Nous sommes extrêmement fiers de nos produits et souhaitons que vous tiriez des années de satisfaction de votre investissement. Nous avons pris toutes les mesures nécessaires pour assurer que ce produit est d'une qualité supérieure en ce qui concerne l'ajustement, la durabilité, la finition et la facilité d'installation.



AUTO VENTSHADE™

Lund International, Ventshade Accessories Division

655 Raco Drive, Lawrenceville, GA 30045, USA

800-241-7219 • Fax 770-339-5839 • Visitez notre site lundinternational.com



© 2005 Lund International, Inc. Tous droits réservés.
Auto Ventshade™, le logo Auto Ventshade™ et le logo AVS™ sont des marques déposées de Lund International, Inc.





Ventvisor® Deflector

Para una instalación adecuada y el mejor ajuste posible, lea todas las instrucciones ANTES de comenzar. Si desea recibir asistencia técnica u obtener piezas faltantes, llame al Servicio al cliente al 1-800-241-7219.

Información importante de seguridad



- PRECAUCIÓN - Antes de conducir, asegúrese de que la visera esté correctamente anclada al vehículo.
- No utilice servicios automáticos de limpieza de vehículos que utilizan cepillos.
- No utilice limpiadores al solvente de ningún tipo.
- Compruebe periódicamente que todos los componentes estén ajustados.

Contenido - Juego de dos piezas

NOTA: El producto real puede variar de la ilustración.

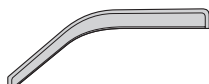

Visera delantera del conductor

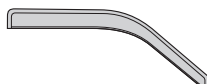

Visera delantera del acompañante



Scotch Brite cojín



Paños esterilizados x 2

Contenido - Juego de cuatro piezas



Visera delantera del conductor



Visera delantera del acompañante



Visera trasera del conductor



Visera trasera del acompañante

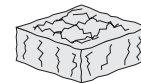

Scotch Brite cojín



Paños esterilizados x 4

Herramientas necesarias



Equipo de limpieza de vehículos



Toalla limpia

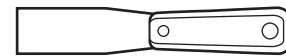

Cuchillo De la Masilla

Preparación antes de pintar o instalar

- Se recomienda realizar un ajuste de prueba para asegurar el posicionamiento y ajuste correctos.
- Compruebe que las piezas se ajusten correctamente antes de pintarlas, ya que no aceptaremos la devolución de piezas modificadas o pintadas.
- Lave los canales de la ventanilla del vehículo para quitar los desechos y la suciedad.
- Seque los canales de la ventanilla con una toalla limpia.

Pasos de instalación

AVISO: La colocación real puede variar con respecto a las ilustraciones.

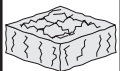

Baje la ventanilla y restriegue el exterior de la banda de goma de la ventanilla en donde colocará la visera. Limpie el área restregada con un paño esterilizado.

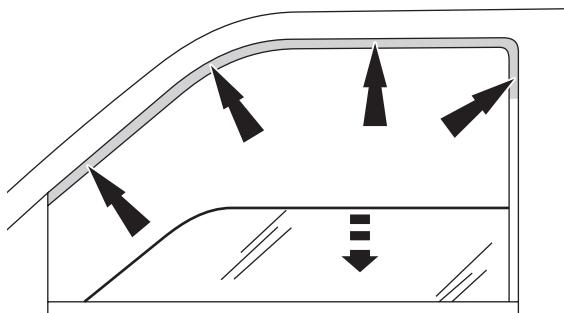

1

Quite la cinta protectora del reborde trasero. Retire 2 pulgs. (5 cm) de cinta protectora de cada uno de los extremos del reborde superior.

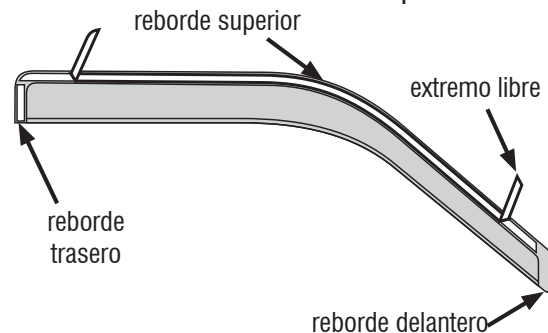

2

Pasos de instalación

AVISO: La colocación real puede variar con respecto a las ilustraciones.

Deslice el reborde frontal por detrás de la cubierta del espejo. Si es necesario, utilice una espátula para crear el espacio. Coloque los rebordes superior y trasero en la banda de goma de la ventanilla.

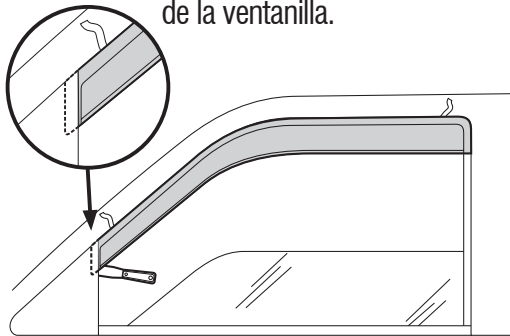

3

Retire la cinta protectora tirando de los extremos libres. Presione sobre los rebordes de cinta superior y trasero para ajustar.

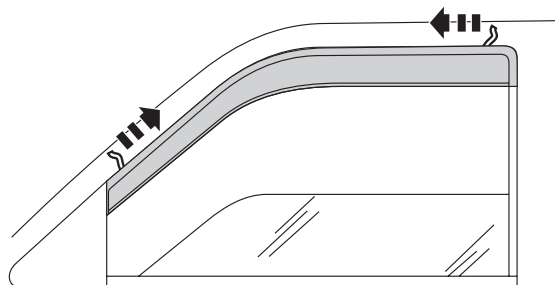

4

Juego de cuatro piezas

La visera trasera se coloca siguiendo los mismos pasos que se siguen para la visera delantera. Coloque la visera en la banda lateral de la ventanilla.

visera trasera colocada en la banda lateral

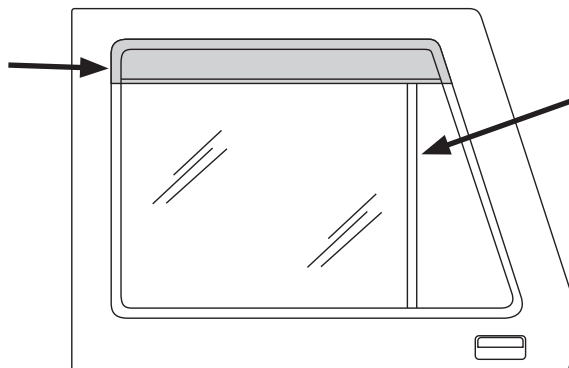

pilar vertical de la ventanilla

5

Cuidado y limpieza

- Limpie solamente con agua jabonosa tibia y seque con un paño limpio.

Felicidades

Usted ha comprado uno de los tantos artículos de calidad de Auto Ventshade™ ofrecidos por Lund International, Inc. Nuestros productos son nuestro mayor orgullo. Deseamos que disfrute de años de satisfacción con su inversión. Hemos realizado todos los esfuerzos para asegurarnos de que su producto sea de la mejor calidad en cuanto a ajuste, durabilidad, acabado y facilidad de instalación.



AUTO VENTSHADE™

Lund International, Ventshade Accessories Division

655 Raco Drive, Lawrenceville, GA 30045

800-241-7219 • Fax 770-339-5839 • Visite nuestro sitio Web: lundinternational.com



© 2005 Lund International, Inc. Todos los derechos reservados.
Auto Ventshade™, el logo de Auto Ventshade™ y el logo de AVS™ son marcas comerciales de Lund International, Inc.

