



AUTOMOTIVE PRODUCTS,

# INSTALLATION INSTRUCTIONS

## DODGE RAM STEP BARS (with 90 degree bent ends)

### APPLICATION:

2009-2015 Dodge Ram 1500 Regular/Crew/Quad Cab

2010-2015 Dodge Ram 2500/3500 Regular/Crew Cab

### PART NUMBER:

23-3540, 23-3545, 23-3550, 23-3555, 23-3560, 23-3565, 23-73540, 23-73550, 23-73560, 25-3540, 25-3545, 25-3550, 25-3555, 25-3560, 25-3565, 26-3540, 26-3550, 26-3560

ITEM	QUANTITY	DESCRIPTION	TOOLS NEEDED
1,2	2	SIDE STEP BAR	18MM SOCKET
3,4	2	FRONT MOUNTING BRACKET	19MM SOCKET
5,6	2	FRONT SUPPORT BRACKET	16MM SOCKET
7,8	2	REAR MOUNTING BRACKET	18MM WRENCH
9	4	1/2" HEX BOLT	RATCHET
10	4	1/2" LOCK WASHER	TORQUE WRENCH
11	4	M8 HEX BOLT	
12	4	M8 FLAT WASHER	
13	4	M8 LOCK WASHER	
14	4	1/2" FLAT WASHER	
15	4	M12 BOLT / M10 NUT PLATE	
16	2	M12 FLAT WASHER	
17	2	M12 LOCK WASHER	
18	2	M12 HEX NUT	
19	4	M12 PLASTIC RETAINER	
20	4	M10-1.5 HEX BOLT	
21	6	M10 FLAT WASHER	
22	6	M10 LOCK WASHER	
23	2	M10 HEX NUT	
24	2	M10 BOLT PLATE	
25	1	M10 FISH WIRE	
26	2	M10 PLASTIC RETAINER	

**ANTI-SEIZE LUBRICANT MUST BE USED ON ALL STAINLESS STEEL FASTENERS TO PREVENT THREAD DAMAGE AND GALLING**

### PROCEDURE

1. Remove contents from box, verify if all parts listed are present and free from damage.  
Carefully read and understand all instructions before attempting installation.  
**Failure to identify damage before installation could lead to a rejection of any claim.**



Westin Automotive Products, Inc.  
320 W. Covina Blvd  
San Dimas, Ca. 91773

Thank you for choosing Westin products  
for additional installation assistance please call  
Customer Service (800) 793-7846  
www.westinautomotive.com

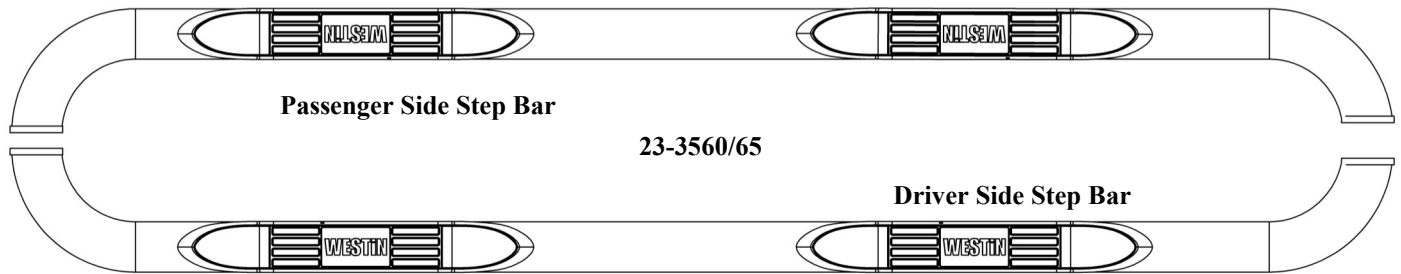
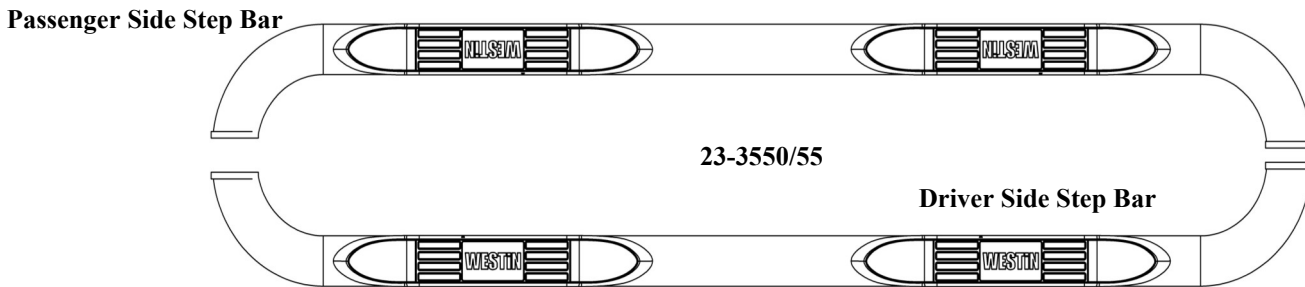
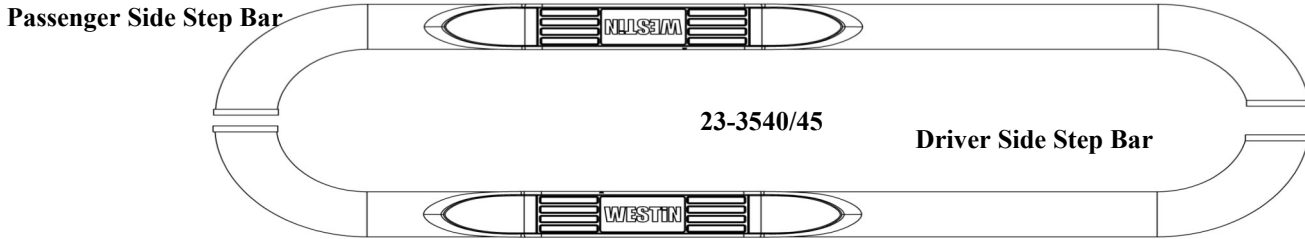
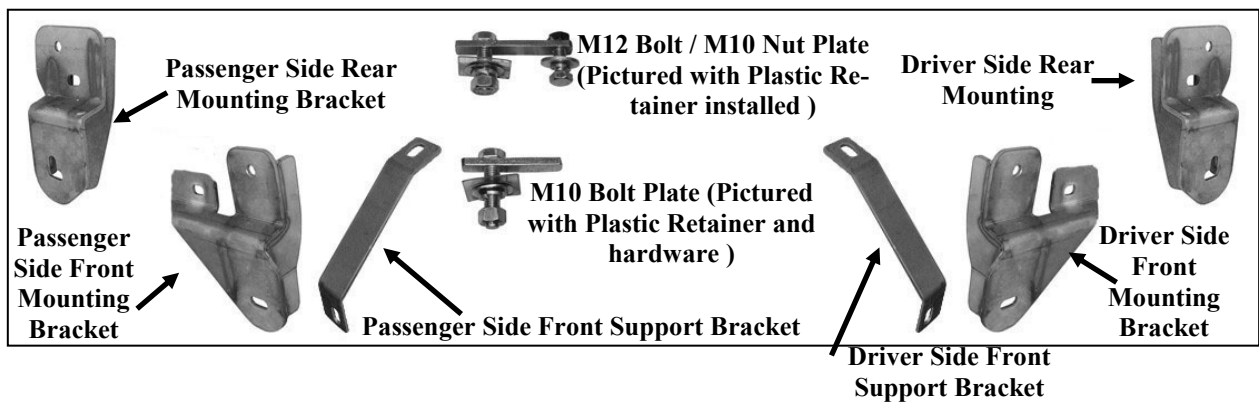

← Front of Side Step Bar

2. Starting at the passenger side-front of the vehicle, remove the tape covering the factory oval holes in the inner body panel located by the front tire.
3. Select (1) M10 Bolt Plate and partially thread a Plastic Retainer onto it, (Fig. 1A). Insert the Bolt Plate into the oval hole, (Fig. 1B). Once the Bolt Plate is inserted, hold the Bolt end with one hand and tighten the Plastic Retainer with your other hand until it is tight against the body panel. **IMPORTANT:** The Plastic Retainer is designed to prevent the Bolt Plate from falling into the body cavity and to aid in installing the Mounting Bracket. **For Mid-year 2015 & up models it will be necessary to use the M10 fish wire to install this bolt plate.** Insert fish wire into small slot and fish it until threaded end is present at large slot (Fig. 2A). Pull this end out slightly and thread M10 bolt plate onto end of fish wire (Fig. 2B). Carefully feed bolt plate into rocker panel by pulling on opposite end of fish wire. Align M10 bolt in slot and remove fish wire. Thread M10 plastic retainer down the bolt plate until it is flush against the sheet metal. (Fig. 2C)



Westin Automotive Products, Inc.  
320 W. Covina Blvd  
San Dimas, Ca. 91773

Thank you for choosing Westin products  
for additional installation assistance please call  
Customer Service (800) 793-7846  
www.westinautomotive.com

4. Next, partially thread a Plastic Retainer onto the threaded end of a M12 / M10 Nut Plate, (**Fig. 1C**). Insert the Bolt and Nut Plate with Plastic Retainer into the factory oval hole, (**Fig. 1B**). **FOR MID-YEAR 2015 & UP MODELS WITH PRE-INSTALLED 8mm THREADED INSERTS, SKIP THIS STEP AND PROCEED TO STEP 5.**
5. Select the passenger side front Mounting Bracket. Position the Mounting Bracket onto the M10 Bolt Plate. Secure the Bracket to the Bolt Plate with (1) M10 flat washer, (1) M10 lock washer & (1) M10 Hex Nut (**Fig. 3**). Do not tighten at this time. Rotate the M12 Bolt/M10 Nut plate until the threaded Nut end lines up with the remaining hole in the Mounting Bracket and body. Thread (1) M10 Hex Bolt, (1) M10 Flat Washer and (1) M10 Lock Washer into the threaded nut plate. **For mid-year 2015 & up Rams equipped with pre-installed 8mm threaded inserts, substitute (1) M8 Hex Bolt, (1) M8 Flat Washer and (1) M8 Lock Washer for the M10 hardware.** Snug but do not tighten hardware at this time.
6. Remove the passenger side front factory body bolt. Select the passenger side Front Support Bracket. Insert the factory body bolt through the Support Bracket and up into its original position, (**Fig. 3**). Line the other end of the Support Bracket up with the oval hole in the Front Mounting Bracket. Snug but do not tighten hardware at this time.
7. Move to the passenger side rear of the vehicle and remove the tape covering the factory oval hole in the inner body panel as described in **Step 2**. Thread a Plastic Retainer onto the threaded end of a Bolt and Nut Plate, (**Fig. 1C & 4**). Insert the Bolt and Nut Plate into the factory hole, (**see Steps 3 & 4**).
8. Select the passenger side rear Mounting Bracket. Position the Mounting Bracket onto the installed Bolt and Nut Plate. Secure it with (1) M12 Flat Washer, (1) M12 Lock Washer and (1) M12 Hex Nut, (**Fig. 5**). Do not tighten at this time. Rotate the Bolt and Nut plate until the threaded Nut end lines up with the remaining hole in the Mounting Bracket and body. Thread (1) M10 Hex Bolt, (1) M10 Flat Washer and (1) M10 Lock Washer into the threaded nut on the Bolt and Nut Plate. **For mid-year 2015 Rams equipped with pre-installed 8mm threaded inserts at rear location, there is no need to align threaded nut with bracket and body. Instead, substitute (1) M8 Hex Bolt, (1) M8 Flat Washer and (1) M8 Lock Washer for the M10 hardware.** Snug, but do not tighten hardware at this time.
9. Select the passenger Side Step Bar and fasten it to the front Mounting Bracket and Support Bracket with the included (1) 1/2" Hex Bolt, (1) 1/2" Lock Washer and (1) 1/2" Flat Washer, (**Fig. 6**). Do not tighten hardware at this time. Attach the Side Step Bar to the Rear Mounting Bracket with (1) 1/2" Hex Bolt, (1) 1/2" Lock Washer and (1) 1/2" Flat Washer, (**Fig. 5**).
10. Level and align Side Step Bars properly and tighten all hardware including the factory body bolt.
11. Repeat Steps 2-10 for driver Side Step Bar installation.
12. Do periodic inspections to the installation to make sure all hardware is secure and tight.



**Fig. 1A**

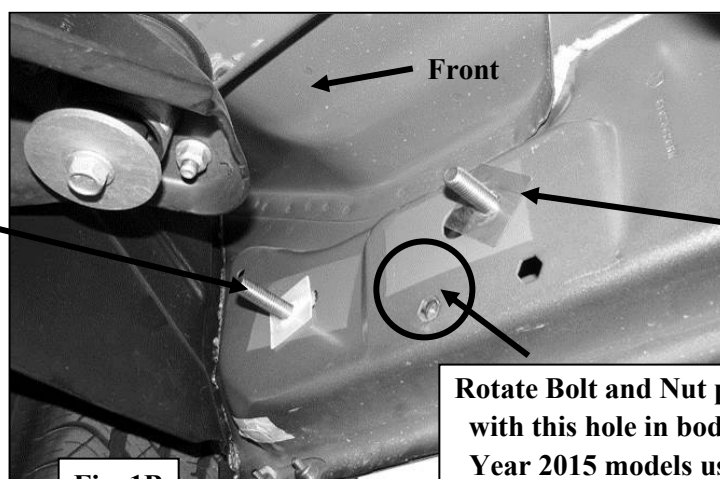

**Fig. 1B**

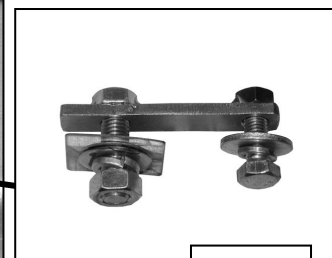
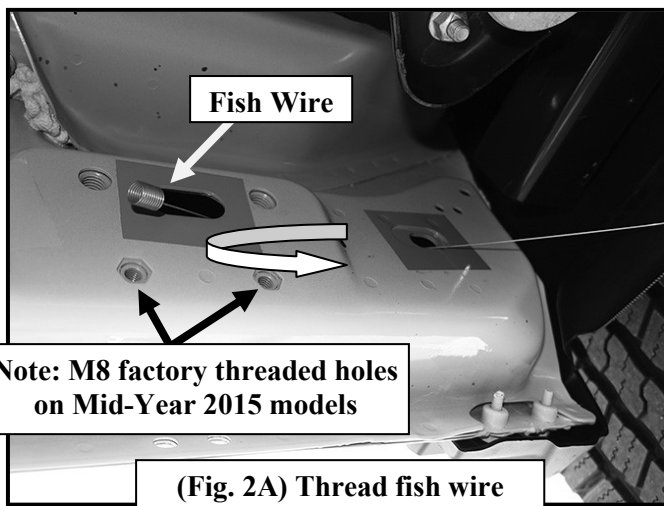

**Fig. 1C**

**Rotate Bolt and Nut plate to line up Nut with this hole in body panel. On Mid-Year 2015 models use 8mm hardware and pre-installed threaded inserts.  
Passenger side shown**



Westin Automotive Products, Inc.  
320 W. Covina Blvd  
San Dimas, Ca. 91773



**Note: M8 factory threaded holes on Mid-Year 2015 models**

**(Fig. 2A) Thread fish wire from small slot into large slot. Driver Side Shown**

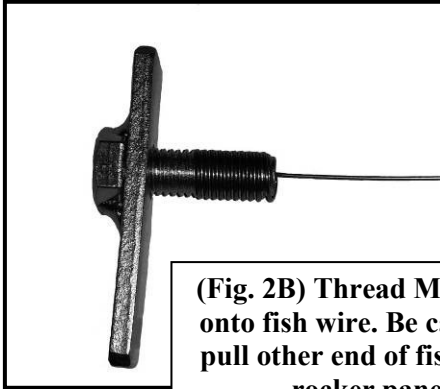

**(Fig. 2B) Thread M10 bolt plate onto fish wire. Be careful not to pull other end of fish wire from rocker panel slot**



**(Fig. 2C) Align M10 Bolt in slot. Driver Side Shown**

**PASSENGER SIDE INSTALLATION PICTURED**

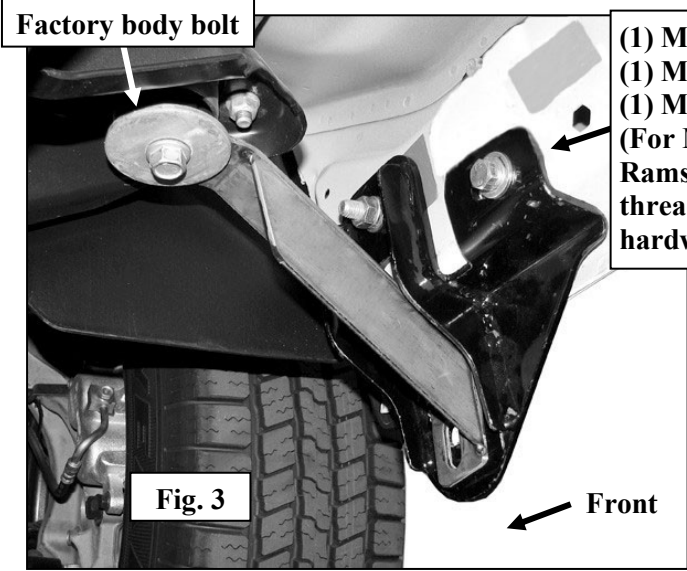

- (1) M10 Hex Bolt**
- (1) M10 Lock Washer**
- (1) M10 Flat Washer**
- (For Mid-Year 2015 Rams with pre-installed threaded inserts use M8 hardware)**

**Fig. 3**

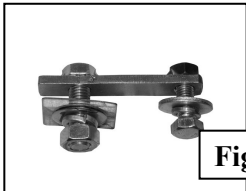

**Fig. 1C**

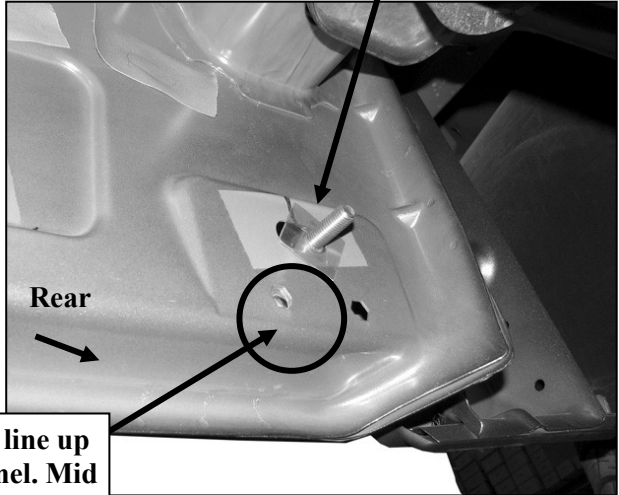

**(Fig. 4) Rotate Bolt and Nut plate to line up the Nut with this hole in the body panel. Mid-Year 2015 & up models with pre-installed 8mm threaded inserts, use M8 hardware**

**CARE INSTRUCTIONS**

- REGULAR WAXING IS RECOMMENDED. DO NOT USE ANY TYPE OF POLISH OR WAX THAT MAY CONTAIN ABRASIVES.
- STAINLESS STEEL PRODUCTS CAN BE CLEANED WITH MILD SOAP AND WATER. STAINLESS STEEL POLISH SHOULD BE USED TO POLISH SMALL SCRATCHES.
- GLOSS BLACK FINISHES SHOULD BE CLEANED WITH MILD SOAP AND WATER.



Westin Automotive Products, Inc.  
320 W. Covina Blvd  
San Dimas, Ca. 91773

Thank you for choosing Westin products for additional installation assistance please call Customer Service (800) 793-7846  
www.westinautomotive.com  
DATE: 9/21/15

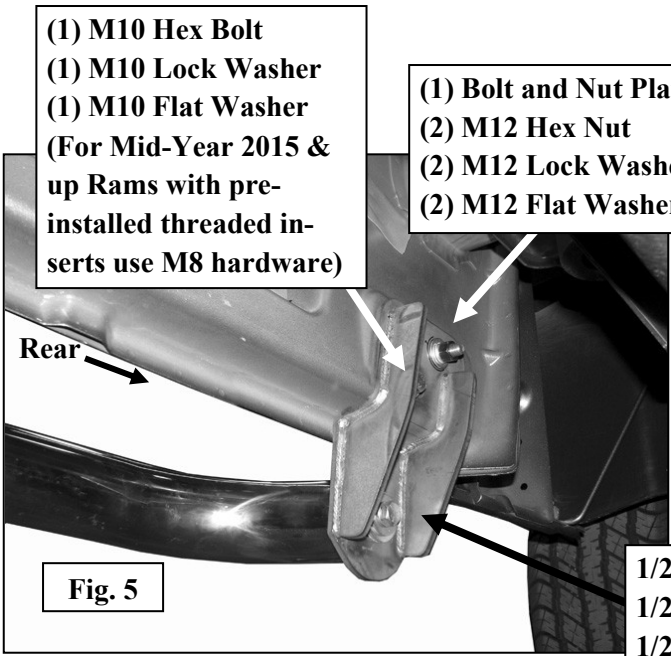

Fig. 5

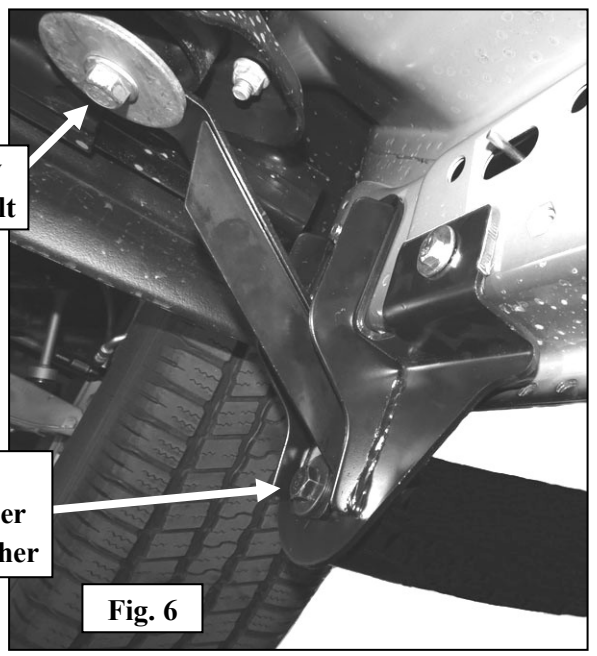

Fig. 6

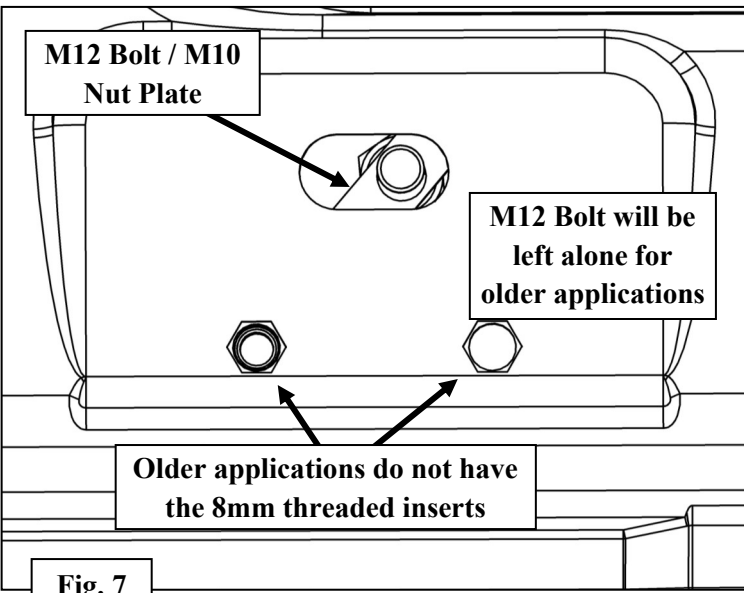
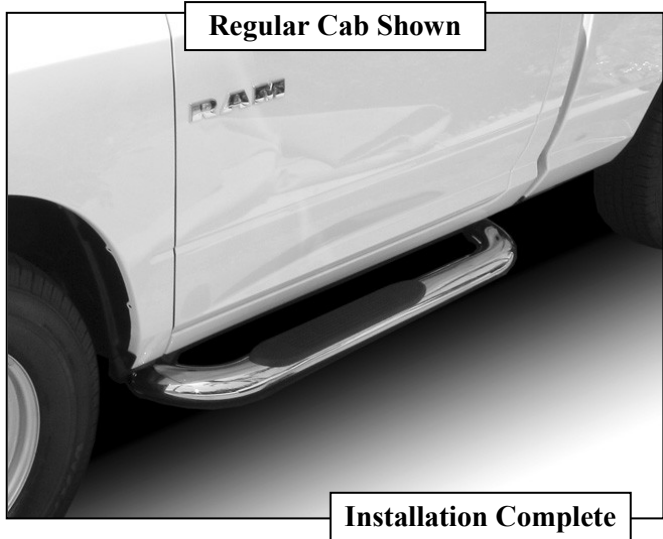

Fig. 7



Installation Complete



Installation Complete

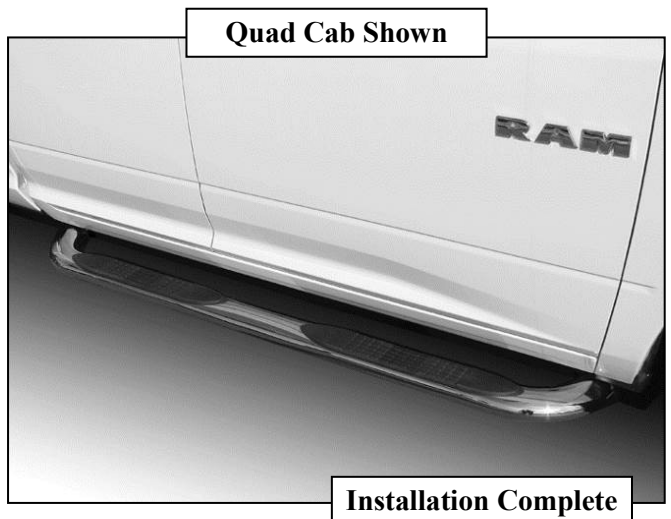

Installation Complete



Westin Automotive Products, Inc.  
 320 W. Covina Blvd  
 San Dimas, Ca. 91773

Thank you for choosing Westin products  
 for additional installation assistance please call  
 Customer Service (800) 793-7846  
 www.westinautomotive.com